



YOUR A800: CONFIGURED TO YOUR PREFERENCES

1 A800 OPTIONS

- First shot
- Second or even third bean grinder
- Bean hopper: 1 x 2 kg, 2 x 1.2 kg, 2 x 0.6 kg, 1 x 2 kg + 1 x 0.6 kg, 2 x 1.2 kg + 1 x 0.6 kg or 2 x 0.6 kg + 1 x 0.6 kg, lockable
- One or two separate powder dosing systems 0,6 kg or 1,2 kg (for chocolate or milk powder), lockable
- Coffee grounds ejector
- Cup sensor
- Raised feet (100 mm)
- Steam spout (S1), Autosteam (S2) (enhanced milk foaming) or Autosteam Pro (S3) (automatic milk foaming)
- Second milk type (only with the SU12)
- Special outlet for jug (instead of steam solutions)

2 MILK AND CLEANING SYSTEM

- FoamMaster™ (FM): hot and cold milk and milk foam, individually adjustable consistency, integrated cleaning system
- EasyClean (EC): automatic cleaning system with manual addition of the cleaning fluid. Perfect hygiene in just a few steps.

3 FLAVOR STATION

Automatic dosing station for up to three flavors.

4 ACCOUNTING SYSTEM

Can be used for various payment methods, e.g. with coins, card. Ideally suited to public/private vending applications.

5 CUP WARMER

With four heatable trays.



FLEXIBILITY

Our product portfolio allows various assembly options – tailored to your needs.



FRANKE

MAKE IT WONDERFUL



590.0598.317/03.20/CH-EN/Subject to dimensional, design and version changes.

A800

Hundreds of different coffee orders, each and every one made to the same high standard? It's easy with the A800, whose 10.4-inch intuitive and configurable touch screen offers full flexibility to anyone who uses it. Add the integrated FoamMaster™ and optional iQFlow™ – as well as the choice of three coffee bean varieties – and make every customer experience unique and memorable. And thanks to its three-boiler system, the A800 is the ultimate multitasker: preparing coffee for one customer, making a cup of tea for another and foaming milk. All at once. Meaning your staff don't have to worry about keeping customers waiting for long.

CAPACITY*	SINGLE	PARALLEL
Espresso	160	238
Cappuccino	149	180
Coffee	109	141
Hot water	164	

*Cups per hour according to DIN 18873



EASYCLEAN
Automatic cleaning system – perfect hygiene in just a few steps



TOUCH SCREEN
10.4-inch comfort display with incredibly simple operating concept and attractive product presentation



FOAMMASTER™
module integrated as standard for perfect foam, every time

FRANKE

MAKE IT WONDERFUL

TECHNICAL DATA

MACHINE MODELS

Model	Power
A800	220-240 V 1LNPE 50/60 Hz 2.6-3.0 kW (16 A) 380-415 V 3LNPE 50/60 Hz 6.7-7.9 kW (16 A)
A800 FM EC	220-240 V 1LNPE 50/60 Hz 4.4-5.2 kW (30 A) 220-240 V 3LPE 50/60 Hz 5.6-7.9 kW (30 A) 200-220 V 2LPE 60 Hz 4.5-5.3 kW (30 A) 200-220 V 2LPE 50/60 Hz 4.5-5.3 kW (30 A) 200-220 V 3LPE 50/60 Hz 6.8-8.1 kW (30 A) 380 V 3LNPE 50/60 Hz 6.7 kW (16 A)
Dimensions	340 mm / 750 mm / 600 mm (W / H / D)
Weight (empty)	approx. 58 kg

WATER CONNECTION

Fixed water connection	Metal hose with union nut G3/8", L = 1500 mm
Water supply line	If possible on installation side: untreated water of drinking water quality (not from household decalcification system)
Water pressure	80-800 kPa (0.8-8.0 bar)
Flowrate	>0.1l/sec
Water temperature	<25°C
Total hardness	4-8 °dH GH (German total hardness) / 7-14 °fH GH (French total hardness) / 70-140 ppm (mg/l)
Carbonate hardness	3-6 °dH KH (carbonate hardness) / 50-105 ppm (mg/l)
Acid content/pH value	6.5-7.5 pH
Chlorine content	<0.5 mg/l

WATER DRAIN

Drain hose	Dia. = 16 mm, L = 2000 mm
------------	---------------------------

ADD-ON UNITS

REFRIGERATION UNIT	SU12 EC (12 l)
Electrical connection	220-240 V 1LNPE 50/60 Hz 0.72 A (10 A) 110-127 V 1LNPE 60 Hz 1.5-1.7 A (10 A) 220 V 1LNPE 50 Hz 0.72 A (10 A) 100 V 1LNPE 50/60 Hz 1.7 A (10 A)
Dimensions	340 mm / 540 mm / 475 mm (W / H / D)
Weight (empty)	approx. 26 kg
Compatible with	Model A800 FM EC
Colors	Black or anthracite

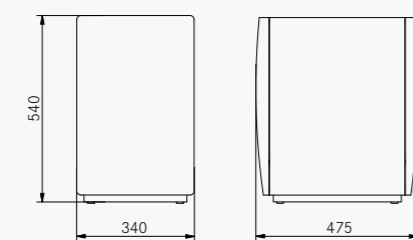
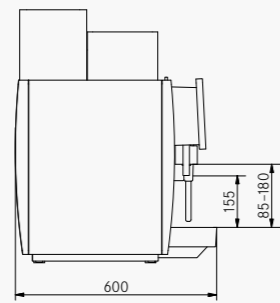
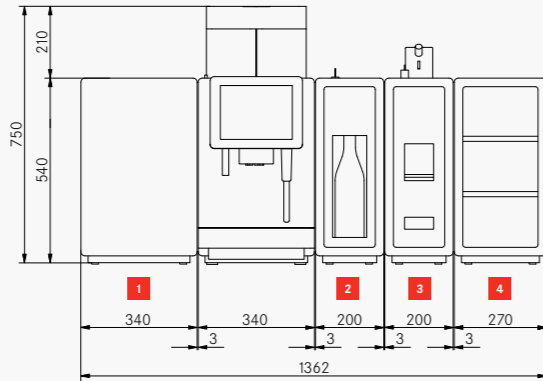

ADD-ON UNITS

REFRIGERATION UNIT	SU05 EC (5 l)
Electrical connection	220-240 V 1LNPE 50/60 Hz 0.72 A (10 A) 120 V 1LNPE 60 Hz 1.5 A (10 A) 220 V 1LNPE 50 Hz 0.72 A (10 A) 100 V 1LNPE 50/60 Hz 1.65 A (10 A) 270 mm / 540 mm / 475 mm (W / H / D)
Dimensions	270 mm / 540 mm / 475 mm (W / H / D)
Weight (empty)	approx. 20 kg
Compatible with	Model A800 FM EC
Colors	Black or anthracite

FLAVOR STATION	FS3
Electrical connection	100-240 V 1LNPE 50/60 Hz 75 W (10 A)
Dimensions	200 mm / 540 mm / 453 mm (W / H / D)
Weight (empty)	approx. 18 kg
Compatible with	Model A800 FM EC
Colors	Black or anthracite

FLAVOR STATION	FSU3
Electrical connection	220-240 V, 1L N PE, 50 W, 50-60 Hz
Dimensions	235mm / 415 mm / 350mm (W / H / D)
Weight (empty)	approx. 15 kg
Compatible with	Model A800 FM EC
Colors	Stainless steel

ACCOUNTING SYSTEM	AC200
Accounting systems	Coin validator, Coin changer, Cashless system
Electrical connection	85-264 V 1LNPE 50/60 Hz (10 A)
Dimensions	200 mm / 630 mm / 453 mm (W / H / D)
Weight (empty)	approx. 18 kg
Compatible with	Model A800 / A800 FM EC
Colors	Black or anthracite

ACCOUNTING SYSTEM	AC125CL
Electrical connection	85-264V 1LNPE 50/60 Hz (10A)
Dimensions	125 mm / 150 mm / 310 mm (W / H / D)
Weight (empty)	approx. 2 kg
Compatible with	Model A800 / A800 FM EC
Colors	Black

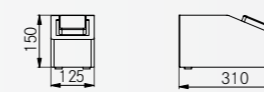
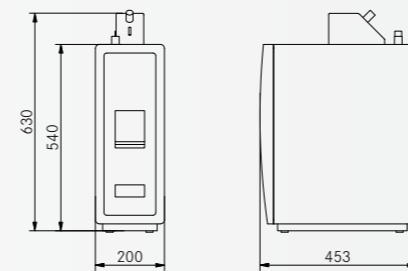
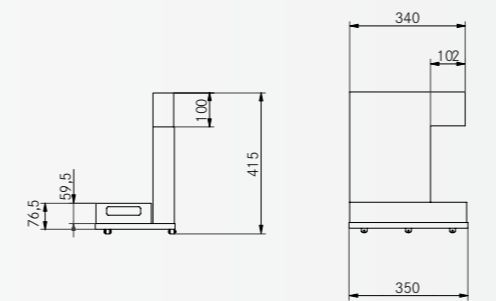
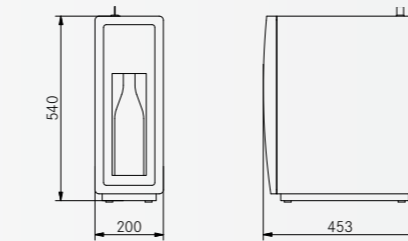
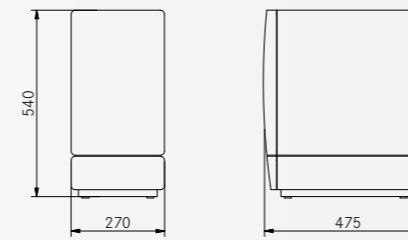

ADD-ON UNITS

CUP WARMER	CW
Electrical connection	220-240 VAC, 1L N PE, 110-130W, 50-60 Hz 110-127 VAC, 1L N PE, 80-130W, 50-60 Hz 100 VAC, 1L N PE, 80W, 50-60 Hz 220 VAC, 1L N PE, 110W, 50-60 Hz 270 mm / 540 mm / 454 mm (W / H / D)
Dimensions	270 mm / 540 mm / 454 mm (W / H / D)
Weight (empty)	approx. 20 kg
Compatible with	Model A800 / A800 FM EC
Colors	Black or anthracite

REFRIGERATION UNIT	KE200 EC (4 l)
Electrical connection	220-240 VAC, 1L N PE, 82 W, 10 A, 50-60 Hz 110 VAC, 1L N PE, 1,5 A, 60 Hz 100 VAC, 1L N PE, 1,5 A, 50-60 Hz 225 mm / 507 mm / 453 mm (W / H / D)
Dimensions	225 mm / 507 mm / 453 mm (W / H / D)
Weight (empty)	approx. 13 kg
Compatible with	Model A800 FM EC
Color	Stainless steel

REFRIGERATION UNIT	UC05 EC (5 l)
Electrical connection	220-240 V 1LNPE 50/60 Hz 1.0A (10 A)
Dimensions	320 mm / 238 mm / 646 mm (W / H / D)
Weight (empty)	approx. 27 kg
Compatible with	Model A800 FM EC
Color	Stainless steel

CHILL & CUP	CC05 EC (5 l)
Electrical connection	200-230 VAC, 1L N PE, 150W, 50-60 Hz 100-120 VAC, 1L N PE, 190W, 60 Hz 380 mm / 581 mm / 473 mm (W / H / D)
Dimensions	320 mm / 581 mm / 473 mm (W / H / D)
Weight (empty)	approx. 29 kg
Compatible with	Model A800 FM EC
Color	Black

